

No.A804: Alum U-BOLT
BONDING CLAMP

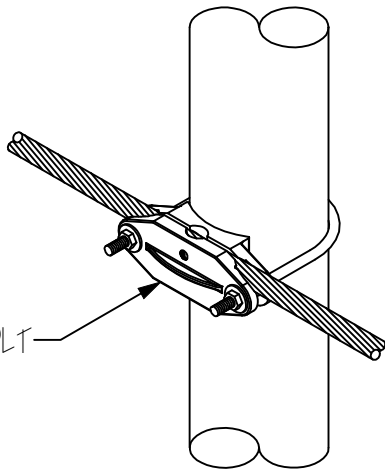

No.A804: Alum U-BOLT
BONDING CLAMP

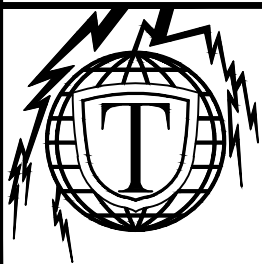
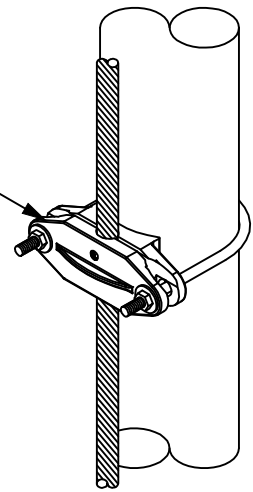

PROJECT:

THOMPSON LIGHTNING PROTECTION, INC.
901 SIBLEY HIGHWAY ST. PAUL, MN 55118-1792
MANUFACTURERS, CONTRACTORS & ENGINEERS

1-800-777-1230
(P): 651-455-7661
(F): 651-455-2545

REVISION

DATE

JOB NO:

FILE:

DR BY:

DATE: 8.24.11

CH BY:

SHH